

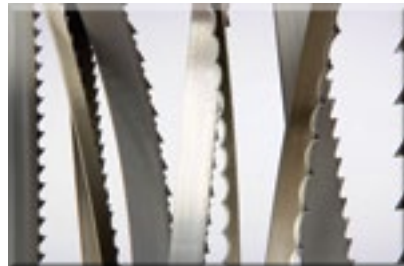

- Blade Accessories
- Bandsaw Blades
- Circular Blades
- Grinder Plates & Replacement Knives
- Injector Needles
- MRO Parts
- Processing Hand Tools
- Replacement Blades
- Specialty Blades
- Tray Pack Blades
- Jarvis® Wellsaws

REFERENCE GUIDE FOR

# BLADES & MRO PARTS



[WWW.BUNZLPD.COM](http://WWW.BUNZLPD.COM) | 800-456-5624



# WE HAVE SO MUCH MORE TO OFFER

*This Blades Catalog showcases our replacement blades, MRO supplies and a selection of processing equipment, but we have so much more to offer. Our inventory includes over 35,000 ready-to-ship items from 14 distribution centers serving Central and North America, including the Caribbean and Mexico!*

Additional supplies and equipment available in our Buyers Guide catalog.

Call to request your **FREE** copy!

**800-456-5624**

Or, visit us online

**www.bunzlpd.com**



También ofrecemos asistencia al cliente en español. Llame al 800-746-7990 para comunicarse con uno de nuestros representantes bilingües.

## ORDERING FROM US IS EASY:



### Phone Orders 800-456-5624

- Monday - Friday, 7:00 am - 5:30 pm CST.
- Knowledgeable sales staff.



### Fax Orders 800-329-5624

- Order 24 hours a day, 7 days a week.
- Easy to use.



### Online Orders www.bunzlpd.com

- Order 24 hours a day, 7 days a week.
- Easy to use.
- Secure.



### Email Orders kochsupplies@bunzlusa.com

- Order anytime.
- Easy to use.

#### NEED ASSISTANCE?

Call 800-456-5624 and we'll be happy to help you.

## TERMS AND CONDITIONS

For full Terms & Conditions information, visit our website [www.bunzlpd.com](http://www.bunzlpd.com)

### Prices

Any prices in this catalog are current prices at publication and are subject to change without notice. In the rare event of a printing error, we reserve the right to charge the correct price. Confirm current prices and availability by phone, fax, or e-mail. Prices are in U.S. dollars and do not include applicable taxes. Current up-to-date pricing can be found on our website [www.bunzlpd.com](http://www.bunzlpd.com).

### Payment Terms



We accept Visa®, MasterCard®, American Express®, Discover® and checks by phone (via TeleCheck®).

We offer credit terms of Net 10 days for customers with a minimum monthly volume of \$500, subject to credit approval.

### Satisfaction Guarantee

When purchasing from our catalog, you can rest assured that any product you order will meet your expectations – guaranteed! That's a promise from our friendly and knowledgeable Customer Service Representatives. However, in the rare case that any stocked supply item fails to meet with your expectations or approval, simply call our toll free number within 30 days and we can arrange for a repair, refund, exchange or credit towards your next purchase, except for those items noted as "No Return" items.

Call for warranty information on non-stock or special order items (i.e. equipment, doors, walls, etc.). **A restocking or repair fee may apply on certain special order items.**

### Returns

Please call our Customer Service Department for details and to obtain a return authorization number before returning items.

### Shipping

Unless specified, we will determine the most expedient and efficient means of shipment based on dimensional weight - UPS or LTL (less than truckload). Alternate delivery may require additional cost. Appropriate charges will be added to your invoice. Additional Terms & Conditions apply.

## Symbol Legend



This symbol highlights an item that is made in the USA.



Shipped by truck freight. Freight rates are available when ordering.



Certain items in this catalog are not returnable and have a 'No Return' symbol next to them.

# BLADES & MRO PARTS

## TABLE OF CONTENTS

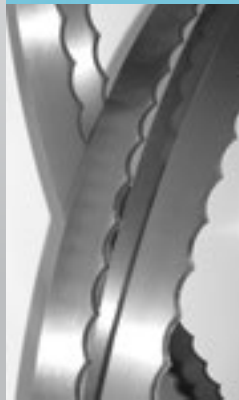

Bone Collector System . . . . .	2
Grinder Plates & Knives . . . . .	2-3
Bandsaw Blades . . . . .	4-6
Edgemaster, Munkfors	
Circular Blades . . . . .	7-9
Specialty Blades . . . . .	10-14
Tray Pack Blades . . . . .	15
Pinch Blocks & Skinner Rollers . . . . .	16
Plucking Fingers . . . . .	17
Poultry Deboning Cones . . . . .	17
Char Marking Equipment . . . . .	17
Replacement Blades & Hand Tools . . . . .	18-19
Skinner, Peeler, Slicer, Dehider, Loin Puller, Rib Puller	
Jarvis® Dehider . . . . .	20
Jarvis® Reciprocating Saws . . . . .	21
Jarvis® Wellsaws . . . . .	22-23
Jarvis® Buster Bandsaw . . . . .	24
Handsaws . . . . .	25
Replacement Injector Needles . . . . .	26-27
Why Choose Jarvis . . . . .	28

**VISIT US ONLINE**  
**WWW.BUNZLPD.COM**  
 FOR ADDITIONAL PROCESSING  
 SUPPLIES & EQUIPMENT

**MEAT CUTTING**  
**BONING MACHINERY**  
**BAND SAWS**  
**SLAUGHTER EQUIPMENT**  
**CARCASS OPENING**  
**SPLITTING SAWS**  
**HOCK CUTTERS**  
**SKINNING MACHINES**



# SPECO™ GRINDER PLATES



## FOUR Important Steps to Determine Which Grinder Plate Is Right For You:

### 1. DETERMINE THE PLATE SIZE OF YOUR GRINDER

Measure the diameter of the grinder plate and match it up to the corresponding plate size below:

<b>Diameter:</b>	2-3/4"	3-1/4"	3-15/16"	5-1/8"	6"	8-5/8"
<b>Plate Size:</b>	#12	#22	#32	#52	#56	#66

### 2. IDENTIFY GRINDER PLATE MOUNTING STYLE

Look at your grinder plate and match up the face shape to one of the styles listed below:



Universal Style  
(Works for Cleveland Style also.)



Cleveland Style

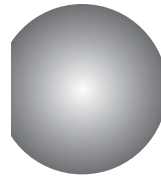

Toledo Style

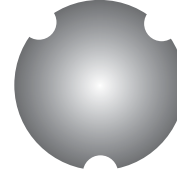

Enterprise Style

### 3. DETERMINE HOLE SIZE

The hole size we are referring to are the holes that are cut into the top side of the grinder plate. Choose from the following sizes:

<b>Hole Size:</b>	1/8"	3/16"	1/4"	3/8"	1/2"	3/4"	1"
-------------------	------	-------	------	------	------	------	----

### 4. HUB OR HUBLESS PLATE?

• Plates with a center hub are stronger and easier to remove from grinder.

• Hubless plates are reversible for extended wear.



2. Enterprise Style HUBBED Plate Pictured

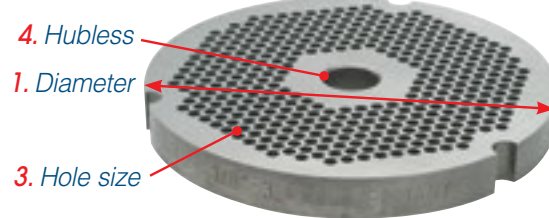

Enterprise Style HUBLESS Plate Pictured

Once you have the FOUR steps above identified, call **800-456-5624** to order your Grinder Plate.

### BONE COLLECTOR SYSTEM

Solid hub bone collector plates in the following sizes:

**Hole sizes:** 3/32", 1/8", 5/32" and 3/16".

**Grinder sizes:** 52, 56, 66 or 11.

**Plate diameters:** 5-1/8", 6", 8-5/8" and 11".



CALL FOR  
DETAILS & PRICING



WHEN ORDERING, PLEASE SPECIFY THE FOLLOWING

- Machine make & model
- Plate hole & size.
- Plate mounting style.

PRICES ARE SUBJECT TO CHANGE — CALL OR VISIT OUR WEBSITE FOR CURRENT PRICING.

## Solid Drop Forged Knives

Constructed of one solid piece of heavy-duty forged steel.

- Excellent for low-volume rugged meat processing jobs
- Not recommended for resharpening
- Most economical knife available



ITEM NO.	PLATE SIZE
1044 00121	#12
3046 51021	#56

## "XL" Knives

Constructed of one solid piece of INOX stainless steel.

- Raised edge allows blades to be resharpened and last longer than solid-forged knives.



ITEM NO.	PLATE SIZE
3046 35481	#22
3046 16011	#32

## Everlasting Knives

- Outwears regular drop-forged or snap-in knives.
- High wear-resistant cutting edge fused solidly to a drop-forged frame.

These knives can be re-sharpened.

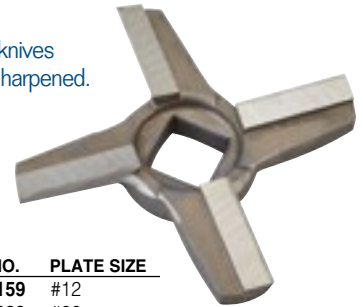

ITEM NO.	PLATE SIZE
3046 7159	#12
3046 7320	#22
3046 0900	#32
3046 6506	#52
3046 4660	#56
3046 6940	#66

## Reversible Grinder Plate with **FREE** Knife

- Computer-drilled holes for precision alignment and total coverage across the plate.
- Maximum number of holes per plate permits higher production volume and cooler cutting.
- Reversible plates are super sharp and can be re-sharpened.
- One **FREE** blade, drop-forged knife comes with each plate.

HUB STYLE PLATES AVAILABLE **CALL FOR DETAILS**

ITEM NO.	PLATE SIZE	HOLE SIZE	
1044 1012	#12 Plate	3/16" Holes	includes Forged Knife
1044 0861	#12 Plate	1/8" Holes	includes Forged Knife
1044 1022	#22 Plate	3/16" Holes	includes Forged Knife
1044 0863	#22 Plate	1/8" Holes	includes Forged Knife
1044 1032	#32 Plate	3/16" Holes	includes Forged Knife
1044 0865	#32 Plate	1/8" Holes	includes Forged Knife



Order  
Grinder Plate,  
GET KNIFE  
**FREE**

## Triumph Knives with Holder

The handiest, most sanitary meat grinder mincer cutting edge ever developed.

- A twist releases the blade insert from the holder. Another twist locks the blade insert securely in place.
- Easy to clean and keep clean.
- Blades are set at an angle which allows only the cutting edge to touch the plate, reducing friction and temperature rise.
- Replacement blades available, see below.



ITEM NO.	PLATE SIZE
3046 3184	#52
3046 3426	#56
3046 3187	#66

## Triumph Blade Insert Replacement Knives

**BLADE ONLY.**  
Holder not included.

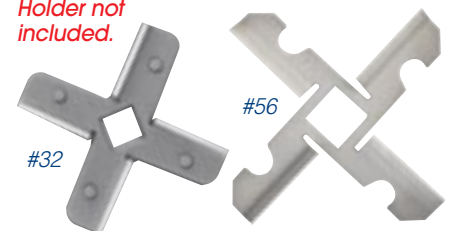

ITEM NO.	PLATE SIZE
3046 50211	#32
3046 31941	#52
3046 31951	#56
3046 70371	#66



## Double Life- Stainless Steel Grinder Plate with a Reversible Hub

Stainless steel plate won't rust!

- Grinder plate comes in Enterprise style with Everlasting knives.
- #32 plate with 1/8" hole size (only).

Reversible hub allows both sides of grinder plate to be used, doubling the plate's life.

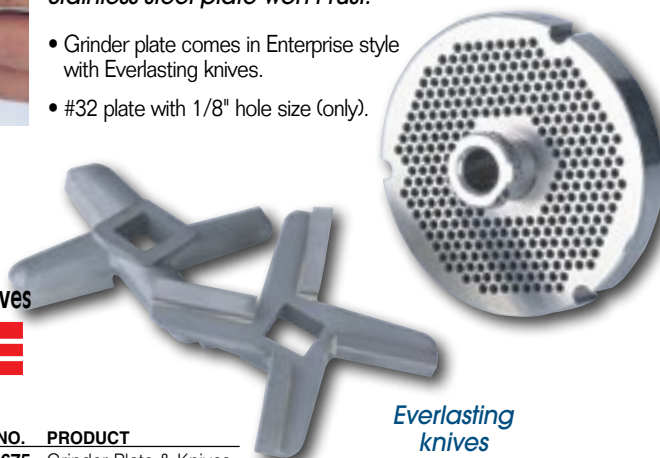

Everlasting knives

Two hard edge grinder knives

**FREE**  
with each plate set!

ITEM NO.	PRODUCT
3363 4675	Grinder Plate & Knives

PRICES ARE SUBJECT TO CHANGE — CALL OR VISIT OUR WEBSITE FOR CURRENT PRICING.



# PERFORMER Bandsaw Blades

High yield 3 or 4 tooth design gives smooth cuts, less waste.

- Made of super-hard steel with precision-stamped, specially tempered tooth set for smooth sharp cutting and long-lasting performance.
- Accurate, narrow blade tooth set permits faster, cleaner cuts.
- Meat waste, bone dust and vibration are reduced and scoring is eliminated.
- All welds are guaranteed for the life of the band.

> 6 per bag - 4 bags per case.

ITEM NO.	MACHINE	LENGTH	BLADE SPEC.
3363 06005	Biro 22	.91"	.5/8" x .022" x 4T
3363 07115	Biro 1433	108"	.5/8" x .025" x 3T
3363 06015	Biro 33	116"	.5/8" x .025" x 3T
3363 06025	Biro 34	118"	.5/8" x .025" x 3T
3363 06035	Biro 3334	124"	.5/8" x .025" x 3T
3363 92705	Biro 3334	124"	.5/8" x .025" x 4T
3363 06045	Biro 44	135"	.5/8" x .025" x 3T

> 6 per bag - 4 bags per case.

ITEM NO.	MACHINE	LENGTH	BLADE SPEC.
3363 06055	Butcher Boy B-12	.98"	.5/8" x .022" x 4T
3363 06065	Butcher Boy B-14	112"	.5/8" x .025" x 3T
3363 06075	Butcher Boy B-16	126"	.5/8" x .025" x 3T
3363 01265	Butcher Boy B-16	126"	.5/8" x .025" x 4T
3363 06085	Butcher Boy SA-20	154"	.5/8" x .025" x 3T

> 6 per bag - 4 bags per case.

ITEM NO.	MACHINE	LENGTH	BLADE SPEC.
3363 06055	Hobart 5212	.98"	.5/8" x .022" x 4T
3363 06105	Hobart 5313	106"	.5/8" x .022" x 4T
3363 06065	Hobart 5514, 5614	112"	.5/8" x .025" x 3T
3363 06125	Hobart 5216	128"	.5/8" x .025" x 3T
3363 06135	Hobart 5700, 5801	142"	.5/8" x .025" x 4T



All EdgeMaster™ PERFORMER Band Saw blades are packaged 6 blades per bag. 4-bags per box case. Minimum order 1 bag.

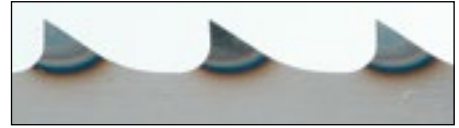

Accurate, narrow blade set permits faster, cleaner cuts. Impulse hardened tooth edge extends band life.



Ziploc poly bags keeps blades dry.



# 2000 Bandsaw Blades

> 6 per bag - 4 bags per case.

ITEM NO.	MACHINE	LENGTH	BLADE SPEC.
3363 44235	Biro 22	.91"	.5/8" x .022"
3363 44285	Biro 33	116"	.5/8" x .025"
3363 44295	Biro 34	118"	.5/8" x .025"
3363 44305	Biro 3334	124"	.5/8" x .025"
3363 44335	Biro 44	135"	.5/8" x .025"

> 6 per bag - 4 bags per case.

ITEM NO.	MACHINE	LENGTH	BLADE SPEC.
3363 44245	Butcher Boy B-12	.98"	.5/8" x .022"
3363 44275	Butcher Boy B-14	112"	.5/8" x .025"
3363 44315	Butcher Boy B-16	126"	.5/8" x .025"
3363 44345	Butcher Boy SA-20	154"	.5/8" x .025"

> 6 per bag - 4 bags per case.

ITEM NO.	MACHINE	LENGTH	BLADE SPEC.
3363 44245	Hobart 5212	.98"	.5/8" x .022"
3363 44255	Hobart 5213	106"	.5/8" x .022"
3363 44275	Hobart 5214, 5614	112"	.5/8" x .025"
3363 44325	Hobart 5216	128"	.5/8" x .025"
3363 44265	Hobart 5700, 5801	142"	.5/8" x .025"

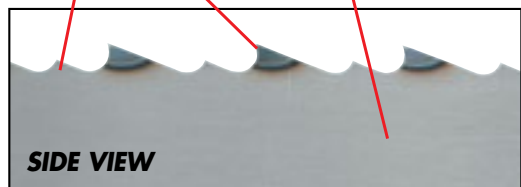

- 1 Special design and construction permits a unique gullet tooth that removes waste and dust during cutting.
- 2 Enables the following tooth to cut uninterrupted and to ultimate capacity.
- 3 Steel composition offers wear resistance properties not available in competitive blades providing a longer life.

PRICES ARE SUBJECT TO CHANGE — CALL OR VISIT OUR WEBSITE FOR CURRENT PRICING.



# MUNKFORS: Our Premier Line of Bandsaw Blades



## QUALITY:

- Committed personnel with long experience in inspecting and evaluating blade design, materials, construction and function.
- Only the best strip steel – meets or exceeds requirements for high strength, exceptional flatness and straightness, excellent weldability and tight tolerance levels.
- Stringent standards of production and quality control guided by ISO 14001.



➤ Sold in 5-pack Bundles only.

**MUNKFORS** leads the development of bandsaw blades in the meat, poultry and fish processing industries.

- Unique manufacturing technology guarantees blades of the highest quality and longevity of performance.
- Quality **EDGEMASTER™ MUNKFORS** blades enable our customers to improve productivity and sharpen their competitive edge.
- Small part for big value – Bandsaw blades account for a small part of production costs, but are critical in maximizing the operating performance and product yield.
- Blades exceed standard running time — maximizing profit.
- Identical ultra-sharp teeth of uniform geometry.
- Allows use of harder steel than in conventional manufacturing methods, which increase blade reliability and stability.

## ADVANTAGES:

- Swedish Steel. • Longer blade lifetime.
- Sharper blades. • Less waste.
- Cleaner cutting. • Minimum downtime.

All blades are individually wrapped and coiled.



➤ Sold in 5-pack Bundles only.

ITEM NO.	SIZE	TOOTH TYPE
<b>C785 29195</b>	72" x 5/8" x .022" x 3TPI	6° Hook Angle
<b>C785 29345</b>	72" x 5/8" x .022" x 4TPI	3° Hook Angle
<b>C785 29355</b>	80" x 5/8" x .022" x 4TPI	3° Hook Angle
<b>C785 29435</b>	82-3/4" x 5/8" x .024" x 6TPI	6° Hook Angle
<b>C785 29365</b>	91" x 5/8" x .022" x 4TPI	3° Hook Angle
<b>C785 29555</b>	95" x 5/8" x .024" x 4TPI	3° Hook Angle
<b>C785 32265</b>	97" x 5/8" x .022" x 4TPI	3° Hook Angle
<b>C785 28495</b>	105-3/4" x 5/8" x .022" x 3TPI	1° Hook Angle
<b>C785 29165</b>	108" x 5/8" x .022" x 3TPI	6° Hook Angle
<b>C785 30365</b>	108" x 5/8" x .024" x 3TPI	6° Hook Angle
<b>C785 29295</b>	112" x 5/8" x .022" x 4TPI	3° Hook Angle
<b>C785 29065</b>	124" x 5/8" x .016" x 3TPI	1° Hook Angle
<b>C785 29055</b>	124" x 5/8" x .016" x 4TPI	3° Hook Angle
<b>C785 29135</b>	124" x 5/8" x .020" x 3TPI	Scalloped
<b>C785 29095</b>	124" x 5/8" x .020" x 4TPI	3° Hook Angle
<b>C785 29255</b>	124" x 5/8" x .022" x 3-4TPI	6° Hook Angle
<b>C785 29175</b>	124" x 5/8" x .022" x 3TPI	6° Hook Angle
<b>C785 31145</b>	124" x 5/8" x .022" x 3TPI	1° Hook Angle
<b>C785 29305</b>	124" x 5/8" x .022" x 4TPI	3° Hook Angle
<b>C785 29525</b>	124" x 5/8" x .024" x 3TPI	6° Hook Angle
<b>C785 29565</b>	124" x 5/8" x .024" x 4TPI	3° Hook Angle
<b>C785 29145</b>	126" x 5/8" x .020" x 3TPI	Scalloped
<b>C785 29315</b>	126" x 5/8" x .022" x 4TPI	3° Hook Angle
<b>C785 29485</b>	126" x 5/8" x .024" x 3TPI	6° Hook Angle
<b>C785 34035</b>	127" x 5/8" x .024" x 3TPI	6° Hook Angle
<b>C785 29125</b>	128" x 5/8" x .020" x 4TPI	3° Hook Angle
<b>C785 29595</b>	131" x 3/4" x .022" x 3TPI	6° Hook Angle

ITEM NO.	SIZE	TOOTH TYPE
<b>C785 29495</b>	135" x 5/8" x .024" x 3TPI	6° Hook Angle
<b>C785 31935</b>	142" x 1" x .024" x 3TPI	1° Hook Angle
<b>C785 29155</b>	142" x 5/8" x .020" x 3TPI	Scalloped
<b>C785 29325</b>	142" x 5/8" x .022" x 4TPI	3° Hook Angle
<b>C785 30355</b>	142" x 5/8" x .024" x 3TPI	6° Hook Angle
<b>C785 29545</b>	142" x 5/8" x .024" x 4TPI	3° Hook Angle
<b>C785 29185</b>	154" x 5/8" x .022" x 3TPI	6° Hook Angle
<b>C785 29335</b>	154" x 5/8" x .022" x 4TPI	3° Hook Angle
<b>C785 29505</b>	154" x 5/8" x .024" x 3TPI	6° Hook Angle
<b>C785 30765</b>	164-1/2" x 3/4" x .022" x 3TPI	6° Hook Angle
<b>C785 29515</b>	164-1/2" x 5/8" x .024" x 3TPI	6° Hook Angle
<b>C785 29605</b>	173" x 3/4" x .022" x 3TPI	6° Hook Angle
<b>C785 29615</b>	173" x 3/4" x .024" x 4TPI	3° Hook Angle
<b>C785 13855</b>	175-5/8" x 3/4" x .022" x 3TPI	6° Hook Angle
<b>C785 32935</b>	175-5/8" x 3/4" x .024" x 3TPI	1° Hook Angle
<b>C785 29445</b>	194-3/4" x 5/8" x .024" x 6TPI	6° Hook Angle
<b>C785 29655</b>	205" x 1" x .032" x 3TPI	1° Hook Angle

➤ Sold in 3-Pack Bundles only.

ITEM NO.	SIZE	TOOTH TYPE
<b>C785 30745</b>	199" x 1" x .032" x 3TPI	1° Hook Angle
<b>C785 29685</b>	216" x 1" x .032" x 3TPI	1° Hook Angle
<b>C785 29625</b>	228" x 1" x .032" x 3TPI	1° Hook Angle
<b>C785 31945</b>	228" x 3/4" x .024" x 4TPI	3° Hook Angle
<b>C785 29695</b>	248" x 1" x .032" x 3TPI	1° Hook Angle
<b>C785 29715</b>	248" x 1" x .032" x 4TPI	3° Hook Angle



Three generations of experience...



PRICES ARE SUBJECT TO CHANGE — CALL OR VISIT OUR WEBSITE FOR CURRENT PRICING.

# Scalloped Bandsaw Blades

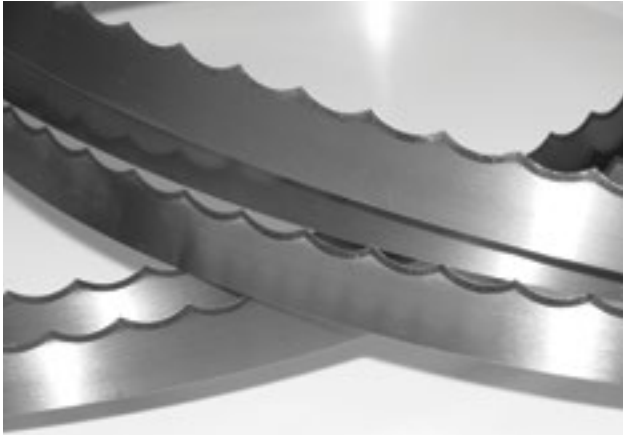

- Ideal for cutting fresh food products, as well as foam and rubber. NOT made for use with hard materials such as bone or frozen food products.
- Blades feature a fully sharpened scallop that is 1/2" long or two scallops per inch.



- Constructed from 1075 series bright polished spring steel.

➤ 6 blades per bag - 4 bags per case.

ITEM NO.	SIZE
3363 00985	98" x 5/8" x .025"
3363 12545	108" x 5/8" x .025"
3363 21125	112" x 5/8" x .025"
3363 21165	116" x 5/8" x .022"
3363 21245	124" x 5/8" x .022"
3363 01245	124" x 5/8" x .025"
3363 01105	126" x 5/8" x .022"
3363 61265	126" x 5/8" x .025"
3363 11285	128" x 5/8" x .022"
3363 2135	135" x 5/8" x .025"
3363 58205	142" x 5/8" x .020"
3363 01085	142" x 5/8" x .022"

➤ 4 blades per bundle.

ITEM NO.	SIZE
3363 80231	135" x 5/8" x .022"

➤ Also available in stainless steel.

**Call for more details.**

See pages 4-5 for bone-cutting bandsaw blades.



**Our experienced customer service representatives are available to answer your questions, find the products you are looking for, check product availability, as well as take your order.**



**800-456-5624**





# PROCESSING BLADES



## Circular Blades



SB=Single bevel  
DB= Double bevel

ITEM NO.	DIAMETER	BORE	THICKNESS	BEVEL	SCALLOPS	AFTERMARKET NAME & NO.
B466 10581	8"	-	.040"	DB	0	Carruthers #235902/ 71058
B466 03221	10"	1-1/8"	.094"	DB	44	Hill# 4010-414
B466 03761	9"	1.25"	.066"	DB	0	Hill# 4010-110M
B466 04041	10"	1.26"	.125"	MISER	0	Hill# 4010-429
B466 04101	12"	1.27"	.118"	MISER	0	Hill# 4010-467
B466 19511	9.055"	1.26"	.078"	DB	0	Hill# 4010-149
B466 12301	10.63"	1.576"	.118"	DB	yes	



## Specialty Blades

ITEM NO.	DESCRIPTION	LENGTH	WIDTH	THICKNESS	CUTTING EDGE	REPLACEMENT FOR OEM	AFTERMARKET NAME & NO.	
B466 82101	Cut-Up Knife	5"	1.574"	.118"	SB	STORK®	Hill# 4010-468	
B466 80851	Leg Cutter Blade	5.48"	1.81"	.060"	DB	DAPEC	Hill# 4010-306	
B466 80871	Scraper Blade	10.45"	1.67"	.090"	SB	CONTHERM	Hill# 401093	
B466 10301	Repak Cutline Knife, short	5-1/8"	.937"	.032"	perf notch	REPAK		<b>CALL FOR MORE INFORMATION</b>
B466 06141	Repak Cutline Blade	6-13/16"	.937"	.032"	DB	REPAK		
B466 87261	Repak Cutline Blade, perf	6-13/16"	.937"	.032"	perf notch	REPAK		

*\*All parts are manufactured for Bunzl Processor Division and are not made, licensed, sponsored or approved by the original equipment manufacturer. All products listed are **replacement parts only**; they are not an original equipment part of the manufacturers listed and Bunzl Processor Division is not affiliated with the manufacturers listed. All references to original manufacturer's equipment are for identification purposes only. All Bunzl parts are manufactured to exacting specifications using the highest quality materials.*

**SIGN UP FOR OUR eDEALS**



Stay connected with us:



Shop our website 24/7! It's the best way to always find current pricing.

Exclusive offers that will not be found anywhere else!  
eDeal sign-up form is available on our website.

[www.bunzlpd.com](http://www.bunzlpd.com)

PRICES ARE SUBJECT TO CHANGE — CALL OR VISIT OUR WEBSITE FOR CURRENT PRICING.



ITEM #	DIAMETER	BORE	THICKNESS	SLOTS	BEVEL	SCALLOPS	REPL. FOR OEM*	OEM NO.*	AFTERMARKET NAME & NO.
F176 21601	10"	1-1/4"	1/8"		DB			BPE1106	HILL# 401062M
F176 21041	11-5/8"	1-3/4"	.118"	4	DB				HILL# 401041S
F176 01811	10"	1"	1/8"	4	DB		ALKUT TOOLS	30-SS10181N	
F176 01141	10"	1"	.125"		DB		ALKUT TOOLS		
E222 28381	252 mm	22.2 mm	4 mm		SB		BAADER®	94.01.0181	
F176 01731	300 mm	22.2 mm	4 mm				BAADER®	94.01.0173	
F176 01681	350 mm	22 mm	4 mm		DB		BAADER®	94.01.0168	
F176 12381	5", Slitter Blade w/Keyway	1.5"	.06"	Y	DB		BRIDGE MACHINE	33996	HILL# 401072
F176 21471	5", Slitter Blade w/Keyway	1.5"	.06"		DB		BRIDGE MACHINE		
F187 21721	3-7/8" Slitter w/2 Keyway 12 & 2 o'clock	1.5"	.032"		DB		BRIDGE MACHINE	33806	
F187 25121	95 mm, Slitter w/2 Keyway 12 & 6 o'clock	38.25 mm	1.2 mm		DB		BRIDGE MACHINE	32541	
F176 21051	11"	1-1/8"	.093"	8	DB		CANTRELL		HILL# 401074S
F176 21491	11"	1-1/8"	.093"		DB		CANTRELL	0210396	HILL# 401074/M&M# 2108
F176 21501	11", Serrated	1-1/8"	.093"		DB	50	CANTRELL	SPECIAL MAKE	
F176 21621	11"	1-1/8"	.071"		DB		CANTRELL	210396	HILL# 401036/M&M# 2109
F176 21481	175 mm	32 mm	2 mm	6	SB		CANTRELL/ MEYN	9924904/ 0990.IDCO.007.00	HILL# 4010-117
F176 21291	7.25"	7/8"	.08"	16	DB		CANTRELL/ SIMMONS	911239/ 02007-01B	HILL# 4010115/M&M# 2117
F176 21261	9"	1/2"	.066"		DB		CANTRELL/ SIMMONS	N027006	HILL# 401032/M&M# 2120
F191 59001	12"	2.109"	.041"		DB		CARRUTHERS	002359-00	
F191 58001	14"	2.109"	.041"		DB		CARRUTHERS	002358-00	
F176 21021	100 mm	22.2 mm	2 mm		SB		DAPEC/MEYN	02.04.000.000	HILL# 4010-474
F176 21451	100 mm, Serrated	22.2 mm	2 mm		SB	18	DAPEC/MEYN	SPECIAL MAKE	
F176 21441	125 mm	22.2 mm	1.5 mm	8	SB		DAPEC/MEYN	08.24.000.001	HILL# 4010113
F176 21461	5"	7/8"	.059"		SB		DAPEC/MEYN	08.24.000.000	HILL# 401079
F176 21201	5"	7/8"	.059"	6	SB		DAPEC/MEYN	02.04.000.030	HILL# 401079S
F176 21091	150 mm	22.2 mm	1.5 mm		DB		DAPEC/MEYN	02.04.000.004/ FB80012	HILL# 4010-154
F176 21141	178 mm, Scalloped	22.2 mm	1.5 mm			44	DAPEC/MEYN	02.04.000.025	
F176 21231	7"	7/8"	.062"	6	DB		DAPEC/MEYN	XB30050/ 02.04.000.027	HILL# 401015
F176 21241	7"	7/8"	.062"		DB		DAPEC/MEYN	08.02.000.001	HILL# 401098
F176 21651	200 mm	32 mm	2 mm		DB		DAPEC/MEYN	08.24.000.002	MEYN# 0990.IDCO.001.00
F176 21001	270 mm, +Tip	40 mm	3 mm		DB		DAPEC/MEYN	08.24.000.003	401081
F176 21431	110 mm	32 mm	2 mm		SB		DAPEC/MEYN	0990.IDCO.053.00	
F176 21121	170 mm	32 mm	2 mm		DB		DAPEC/MEYN	0990.IDCO.003.00	
F176 21661	6-15/16"	7/8"	.080"		DB		DAPEC/MEYN	0990.DICO.050.00	
F176 21561	175 mm	32 mm	2 mm		SB		DAPEC/MEYN	0990.IDCO.002.00	HILL# 4010-140
F176 21571	175 mm, Scalloped	32 mm	2 mm			32	DAPEC/MEYN	SPECIAL MAKE	
F176 21161	250 mm	32 mm	2.5 mm		SB		DAPEC/MEYN	0990.IDCO.006.00	HILL# 4010-142
F176 21541	250 mm, 1 Pin Hole	32 mm	3 mm		DB		DAPEC/MEYN	0990.IDCO.047.00	
F176 21301	250 mm	32 mm	3 mm	6	DB		DAPEC/MEYN	SPECIAL MAKE	

**CALL 800-456-5624 FOR MORE INFORMATION**

*\*All parts are manufactured for Bunzl Processor Division and are not made, licensed, sponsored or approved by the original equipment manufacturer. All products listed are replacement parts only; they are not an original equipment part of the manufacturers listed and Bunzl Processor Division is not affiliated with the manufacturers listed. All references to original manufacturer's equipment are for identification purposes only. All Bunzl parts are manufactured to exacting specifications using the highest quality materials.*

PRICES ARE SUBJECT TO CHANGE — CALL OR VISIT OUR WEBSITE FOR CURRENT PRICING.

**EdgeMaster™**

**CIRCULAR BLADES**



**Serrated Blade**

**SB=Single Bevel**

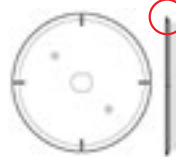

**DB=Double Bevel**



**25/30 Bore with Slots**

ITEM #	DIAMETER	BORE	THICKNESS	SLOTS	BEVEL	SCALLOPS	REPL. FOR OEM*	OEM NO.*	AFTERMARKET NAME & NO.
F176 21611	270 mm, Serrated	40 mm	3 mm		DB	44	DAPEC/MEYN	02.04.000.014	4010198
F176 00351	310 mm, Halver Blade	40 mm	3 mm		DB		DAPEC/MEYN	02.04.000.035	
E075 10641	2.5"	1-3/8"	1/8"				DOUGHBOY		
F176 21551	4.5"	1"	.093"		SB		FOODCRAFT	66020198	HILL# 401078
F176 21081	14.5", Keel	1-1/8"	.095"		DB		FOODCRAFT	66015795	HILL# 401022
F176 21211	6.25"	1"	.090"	4	DB		FOODCRAFT		HILL# 401021S/M&M# 2113S
F176 21061	12" Scalloped Serrated	1-1/8"	.093"		DB	50	JOHNSON	41822400	HILL# 4010-249
F176 80571	10"	1-1/8"	.057"		DB		JOHNSON		HILL# 401097/M&M# 2125
F176 21071	12"	1-1/8"	.093"		DB		JOHNSON	41822500	HILL# 401043
F176 21251	9"	1-1/8"	.071"		DB		JOHNSON		HILL# 401053/M&M# 2124
F176 21031	10"	1-1/8"	1/8"	8	DB		LEWIS	LH8410/LE90-010	HILL# 401062S/M&M# 2102S
F176 21591	10"	1-1/8"	1/8"		DB		LEWIS	LH8412/LE90-012	HILL# 401062/LH8412
F176 21281	60 mm	11 mm	1 mm		DB		MAREL®	009-0021-2587	
F187 46001	250 mm, Micro Serrated	32 mm	3 mm		SB	MICRO SERR	MEYN MAESTRO	0990.ICCO.056.00	Hill# 4010-462
F187 12391	100 mm, Packaging Blade Tin Coated	30 mm	2 mm		DB		OSSID®		CP015
F187 59111	100 mm, Packaging Blade	30 mm	2 mm		DB		OSSID®	42-2591-1	
F176 21421	2-3/8" Square Edged	1"	.104"				PACKRITE	82048500A	
F264 29981	80mm, slotted w/ hub	30mm	10mm	Y			SIMMONS/Tiromat	700A146K	
F176 21711	7.25"	7/8"	.080"		DB		SIMMONS	02007-02B	
F176 21271	9"	5/8"	.080"		DB		SIMMONS/Cantrell	02009-05/N027005	HILL# 401017 & 401034 Sub# CBC52122
F176 21581	9"	5/8"	.063"	8	DB		SIMMONS		HILL# 401017S
F176 00051	110mm"	25/30	2mm		SB		STORK®	555710	
F176 21101	165 mm	25/30 ob	2 mm	4	DB		STORK®		
F176 21111	165 mm	25/30 ob	2 mm	4	SB		STORK®	518391G	HILL# 401016
F176 21131	175 mm	25/30 ob	2 mm	4	DB		STORK®	507971	
F187 33571	175 mm, Micro Serrated	25/30 ob	2 mm			MICRO SERR	STORK®	3943357	HILL# 401073
F176 21151	200 mm	25/30 ob	2 mm	4	SB		STORK®	683074	HILL# 4010-217
F176 21631	200 mm	25/30 ob	3 mm	4	SB		STORK®	SPECIAL MAKE	
F176 21701	250 mm	25/30 ob	2 mm	4w			STORK®	518180	HILL# 4010-224
F176 21011	250 mm	25/30 ob	2 mm		SB		STORK®	504237	HILL# 4010-179
F176 21171	250 mm	25/30 ob	2 mm	4n	SB		STORK®	596746	HILL# 4010-179S
F187 03251	250 mm, Micro Serrated	25/30 ob	2 mm			MICRO SERR	STORK®	3930325	
F176 21181	250 mm	25/30 ob	2 mm	12	DB		STORK®	255502	
F176 21191	300 mm, Serrated	25/30 ob	3 mm			yes	STORK®	673314/671371	
F176 21371	350 mm	25/30 ob	3 mm		DB		STORK®	669290	
F191 18221	16.53" (dished)	1-1/4"	3/4"		D2	0	Toby	SK-T950182D2	
F264 61191	75mm Circular Anvil Cutter w/ key	35mm	1.25mm		DB	0			

**CALL 800-456-5624 FOR MORE INFORMATION**

*\*All parts are manufactured for Bunzl Processor Division and are not made, licensed, sponsored or approved by the original equipment manufacturer. All products listed are replacement parts only; they are not an original equipment part of the manufacturers listed and Bunzl Processor Division is not affiliated with the manufacturers listed. All references to original manufacturer's equipment are for identification purposes only. All Bunzl parts are manufactured to exacting specifications using the highest quality materials.*

PRICES ARE SUBJECT TO CHANGE — CALL OR VISIT OUR WEBSITE FOR CURRENT PRICING.



ITEM #	PRODUCT	DESCRIPTION	REPLACEMENT FOR OEM*	OEM NO.*	LENGTH	WIDTH	THICKNESS	CUTTING EDGE	MOUNT HOLES	AFTERMARKET NAME & NO.
F187 24011		Tape Blade	3M™	78-8017-9173-8	2.56"	1.1"	1.5 mm	SB	3 slots	
F187 25071		Specialty Blade	BAADER®	940.31.45.011	4"	2-5/8"	5 mm	SB	2 slots	
F176 23461		Vent Drill Eviscerator	BAADER® LINCO®	92346/ 19285661	61 mm	29.5 mm OD	25 mm ID	SB	slot locks	
F176 21321		Hock Cutter Blade	BARKER		29"	1/2"	1/8"	DB	4	HILL# 401002NS M&M# 2101
F176 21641		Hock Cutter Blade w/Notches	BARKER		29"	1/2"	1/8"	notched	4	HILL# 401002
F176 21361		Star Wing Blade	CANTRELL	NO-46210	12"	1-1/2"	1/8"	DB	0	CP-057
F176 78101		Spiral Slicer	CARRUTHERS	000178-10	21-5/8"		.062"	SB	Y	
F176 01051		Spiral Slicer w/ 4 mounting holes	CARRUTHERS	000178-09	21-5/8"		.100/.110"	SB	4	
F187 22091		Piercing Blade	CRYOVAC®	FUR-58463	45.6 mm	10.3 mm	.80 mm	45 deg w/pt	1	
F186 00011		Narrow Cut Blade	CRYOVAC®	PE20S074	345mm	15mm	1.2mm	SB	0	PE20S04SB
F187 22111		Packaging Cutoff Blade	CRYOVAC®	2070A-8550	385 mm	19 mm	1.3 mm	serrated	Y	
F187 22131		.080" Standard Packaging Cutoff Blade	CRYOVAC®	V01S004	414 mm	46.25 mm	.080" STD	serrated	2	
F187 22121		.125" Heavy Duty Packaging Cutoff Blade	CRYOVAC®	THICK VERSION PV01S004	414 mm	46.25 mm	1.25 HD	serrated	Y	
F187 22151		Packaging Cutoff Blade	CRYOVAC®	PV01S005	514 mm	35 mm	.50 mm	serrated	Y	
F187 15351		Packaging Cutoff Blade	CRYOVAC®	PV23S001	570.2 mm	50.5 mm	.80 mm	serrated	2	
F264 05261		Packaging Shear Blade	CRYOVAC®	PV02S002	526 mm	50 mm	1 mm	serrated	Y	
F187 51661		2-Tooth Piercing Blade	CRYOVAC®	4-35166	41 mm	45 mm	1 mm	SB 2-tooth	2	
F187 17681		4-Toothed Piercing Blade	CRYOVAC®	4-35165	75 mm	47 mm	.80 mm	DB 4-tooth	2	TGW# AS1768
F187 76711		4-Toothed Piercing Blade	CRYOVAC®	AS17671	80 mm	45 mm	.80 mm	DB 4-tooth	4	TGW# AS1767-1

PRICES ARE SUBJECT TO CHANGE — CALL OR VISIT OUR WEBSITE FOR CURRENT PRICING.

\*All parts are manufactured for Bunzl Processor Division and are not made, licensed, sponsored or approved by the original equipment manufacturer.

All products listed are **replacement parts only**; they are not an original equipment part of the manufacturers listed and Bunzl Processor Division is not affiliated with the manufacturers listed. All references to original manufacturer's equipment are for identification purposes only. All Bunzl parts are manufactured to exacting specifications using the highest quality materials.

ITEM #	PRODUCT	DESCRIPTION	REPLACEMENT FOR OEM*	OEM NO.*	LENGTH	WIDTH	THICKNESS	CUTTING EDGE	MOUNT HOLES	AFTERMARKET NAME & NO.
F186 21351		Leg Processor Blade	DAPEC	LEP-2015	138.8 mm	35mm	1.6 mm	DB	1 hole 2 slots	
F187 44401		HD Thick Version, Large Leg Processor Blade	DAPEC	LPG-1011	193.8 mm		1.6 mm	DB	2 slots	HILL# 4010-338
F176 21311		Wing Blade	DAPEC	FB038055	12-3/4"	1-1/2"	1/16"	DB	0	HILL# 401046
F176 21341		Half Circle Blade	DAPEC	77.50.008.500	239 mm	80 mm	3 mm	DB	4 slots	
F187 13931		Leg Processor Blade	DAPEC	LEP-2015	139 mm	33 mm	1 mm	DB	1 hole 2 slots	
F187 21881		Tape Blade	DEKKA	06-015	60 mm	24.5 mm	1.6 mm	serrated	2 slots	
F187 08881		Breast Splitter	EQUIMEX		214 mm	.19 mm	2 mm	DB	2	
F186 23021		Backscore Knife	FOODCRAFT	6015278	3-3/8"	3/4"	1/8"	DB	1	HILL# 401008
F186 23031		Leg Processor Knife	FOODCRAFT	6015277	3-1/2"	5/8"	1/8"	DB	N	HILL# 401009
F186 22761		Resharpenable Processor Blade	FOODCRAFT		3-3/4"	1/2"	.06"	DB	N	HILL# 401010
F186 30201		Leg Tendon Blade	FOODMATE	IF005.002.015	191mm	30mm	2mm	straight	2 slots	
F187 21921		Leg Processor	FOODMATE	IF.05.002.005	192 mm	25.25 mm	3.1 mm	DB	4 slots	
F187 19451		Packaging Blade	HART		17"	1"	.040"	serrated		
F625 04461		Slicer Blade	HAYSEN	10137A0405	446 mm	20 mm	.080 mm	scalloped	Y	CBC4462080
F176 21381		Evisceration Vent Drill	JOHNSON	2421530321CCW	2.52"	1.237"	.97"	Bore	slot locks	
F176 21391		Evisceration Vent Drill	JOHNSON	2421530320CW	2.52"	1.237"	.97"	Bore	slot locks	
0098 62525		Celanese Vent Opener	SS JOHNSON	R-016252S	1.625"	.740"	.036"	DB	2 slots	HILL# 401045

PRICES ARE SUBJECT TO CHANGE — CALL OR VISIT OUR WEBSITE FOR CURRENT PRICING.

\*All parts are manufactured for Bunzl Processor Division and are not made, licensed, sponsored or approved by the original equipment manufacturer. All products listed are replacement parts only; they are not an original equipment part of the manufacturers listed and Bunzl Processor Division is not affiliated with the manufacturers listed. All references to original manufacturer's equipment are for identification purposes only. All Bunzl parts are manufactured to exacting specifications using the highest quality materials.

ITEM #	PRODUCT	DESCRIPTION	REPLACEMENT FOR OEM*	OEM NO.*	LENGTH	WIDTH	THICKNESS	CUTTING EDGE	MOUNT HOLES	AFTERMARKET NAME & NO.
F187 94401		Chub Cutoff Knife	K-PAK	007-52671-000						
E516 20001		V-Anvil Lower	K-Pak	007-52702-000						
E516 30001		V-Anvil upper	K-Pak	007-52703-000						
E516 00401		V-insert Cutoff	K-Pak	007-60650-040						
E516 10201		V-punch	K-Pak	007-52701-020						
E516 01501		V-Assembly	K-Pak	007-53810-150						
E516 00501		V-Assembly	K-Pak	007-53810-050						
7949 30181		Opener Blade	LINCO®	61-0005	2.458"	.750"	.036"	DB	2 slots	IDSL# TE03-018
F187 21861		Processing Blade	LINCO®	2103953/ 624773	190 mm	25 mm	1.2 mm	DB	4 slots	
F264 26401		Tape Blade	LITTLE DAVID	PCS11B4	62 mm	25 mm	.50 mm	serrated	3	
F187 90161		L-Shaped Blade	MAREL®	0200-999- 80118201	341.91 mm	90.09 mm	1.5 mm	L-shp DB	2	NOR-80118201
F187 96701		LH Leg Processor Blade	MAREL®/STORK®	249670	115 mm	36.5 mm	2 mm		2 slots	
F187 96711		RH Leg Processor Blade	MAREL®/STORK®	249671	115 mm	36.5 mm	2 mm		2 slots	
7949 31611		Carbon Concave Hook Opener	MEYN					DB	3 holes 2 slots	HILL# 401042 IDSL#TE03-161
F187 38671		Groin Cut Blade	MEYN	0990.IDC1.015.00						
F187 22161		Vent Opener Blade	MEYN	0774.000.000.315	104 mm	45 mm	.05 mm	serrated	2	4010-311
F176 56001		LH Leg Processor Blade	MEYN	77.50.005.600	120 mm	40 mm >26 mm	3 mm			
F176 57001		RH Leg Processor Blade	MEYN	77.50.005.700	120 mm	40 mm >26 mm	3 mm	SB		

PRICES ARE SUBJECT TO CHANGE — CALL OR VISIT OUR WEBSITE FOR CURRENT PRICING.

\*All parts are manufactured for Bunzl Processor Division and are not made, licensed, sponsored or approved by the original equipment manufacturer.

All products listed are **replacement parts only**; they are not an original equipment part of the manufacturers listed and Bunzl Processor Division is not affiliated with the manufacturers listed. All references to original manufacturer's equipment are for identification purposes only. All Bunzl parts are manufactured to exacting specifications using the highest quality materials.



ITEM #	PRODUCT	DESCRIPTION	REPLACEMENT FOR OEM*	OEM NO.*	LENGTH	WIDTH	THICKNESS	CUTTING EDGE	MOUNT HOLES	AFTERMARKET NAME & NO.
F187 22141		Packaging Blade Tin Coated	M-TEK	113021C1	16-5/8"	1.062"	.079"	serrated	Y	TARHEEL#
F264 00011		Oval Shaped Tray	MULTIVAC	200051896	40 mm	1 mm	2 mm	serrated	Y	
F187 09411		SS Slitter Blade 2 pieces DB	MULTIVAC	79.915.2009.41	90 mm	42 mm	.2 mm	DB	3 per	
F187 09421		SS Slitter Blade 2 pieces SB	MULTIVAC	79.915.2009.42	90 mm	42 mm	2 mm	SB	3 per	
F264 04051		Cutoff Blade	MULTIVAC	11086841	405mm	40mm	1mm	DB	2	
F264 04761		260mm Cutoff Blade	Omori	HFM147001	260mm	32mm	2mm	SB	3	
F187 22101		Packaging Blade	OSSID®	025-000-17	10-1/2"	.393"	.04"	serrated	2	
F187 25961		Packaging Cutoff Blade	OSSID®	2-475-3	280 mm	45 mm	1.2 mm	serrated	4 slots	
F187 22061		Packaging Cutoff Blade	PACMAC	9202-0009	20-1/4"	1.05"	.064"	serrated	2	HILL# 4010-207
F187 00641		Tin Coated Serrated Packaging Blade	PACMAC	9200-064	20-1/4"	1.05"	.064"	serrated	2	2
F187 95211		Cutoff Blade w/ Tear Notch	PACMAC	9202-00095SDB2-1	20-1/4"	1.05"	.064"	DB scalloped	w/ tear notch	
F187 00951		Packaging Scalloped	PACMAC	9202-00095	20-1/4"	1.05"	.064"	scalloped	2	
F187 22821		Perforating Blade	PACMAC	9502-0009P	20-1/4"	1.05"	.064"	Y		
F176 00171		Spreader Bar	PACMAC	9212-0017	29"		1/2"			
F187 19151		Net Blade	POLY CLIP®	71678	175 mm	19 mm	2 mm	SB	2	
F187 32011		Crosscut Blade	REISER	A-352-04320.1	12"	1-3/8"	1 mm	SB	2	
F187 22071		Packaging Blade	SANDIACRE	KN14464	335 mm	18.5 mm	2.5 mm	Serrated	2	
F187 22081		Packaging Blade	SANDIACRE		365 mm	18.5 mm	2.5 mm	Serrated	Y	

PRICES ARE SUBJECT TO CHANGE — CALL OR VISIT OUR WEBSITE FOR CURRENT PRICING.

\*All parts are manufactured for Bunzl Processor Division and are not made, licensed, sponsored or approved by the original equipment manufacturer.  
 All products listed are **replacement parts only**; they are not an original equipment part of the manufacturers listed and Bunzl Processor Division is not affiliated with the manufacturers listed.  
 All references to original manufacturer's equipment are for identification purposes only. All Bunzl parts are manufactured to exacting specifications using the highest quality materials.

ITEM #	PRODUCT	DESCRIPTION	REPLACEMENT FOR OEM*	OEM NO.*	LENGTH	WIDTH	THICKNESS	CUTTING EDGE	MOUNT HOLES	AFTERMARKET NAME & NO.
F187 22011		JLR Blade LH	STORK®	608788	80.5 mm	31mm	3 mm	SB	3	HILL# 4010-177
F187 22021		JLR Blade RH	STORK®	608789	80.5 mm	31 mm	3 mm	SB	3	HILL# 4010-178
F264 29981		Circular Slitter Blade	Tiromat	700A46K	80 mm	30 mm	1mm	SB	0	
F187 87511		Dicer Blade Positive	Treif	58751	182 mm	12 mm	.75 mm		2	
F187 87521		Dicer Blade Negative	Treif	58752	182 mm	12 mm	.75 mm		2	
F187 20501		Cutoff Knife	TIPPER TIE		3/3/04	1"	1/8"	SB	1	11-0140-05
F187 33521		Packaging Blade	Triangle	A83352	465 mm	.25 mm	1.5 mm	serrated	2	
F187 19301		Cutoff Blade	Triangle	A12279	13-7/8"	1"	0.062	SB	2	
F187 03451		Packaging Cutoff Tin Coated Blade	Triangle		345 mm	26 mm	1.2 mm	SB scalloped	2	Hill# 4010-282
F264 04741		Piercing Blade	Triangle		474mm	25.4mm	1.5	serrated	2	4010-340
F264 04751		Tin Cutoff Blade	Triangle	A38349	474mm	25mm	1mm	serrated	2	
F264 06611		Tin Slitter Blade 2-pieces			115mm	25mm	1mm	DB	3 per	
F264 04951		Tapered Tin Blade			495mm	70/60mm	.8mm	serrated	7 slots	
F264 04771		EZ Open Blade		6254938	425mm	57mm	3.5/2.5mm	serrated	2	

\*All parts are manufactured for Bunzl Processor Division and are not made, licensed, sponsored or approved by the original equipment manufacturer.

All products listed are **replacement parts only**; they are not an original equipment part of the manufacturers listed and Bunzl Processor Division is not affiliated with the manufacturers listed. All references to original manufacturer's equipment are for identification purposes only. All Bunzl parts are manufactured to exacting specifications using the highest quality materials.

PRICES ARE SUBJECT TO CHANGE — CALL OR VISIT OUR WEBSITE FOR CURRENT PRICING.



### ASK US ABOUT:

- Rollstock
- Vacuum Pouches
- Shrink Bags
- Poly Food Bags
- Food Equipment



Call for your **FREE** copy of our **Flexible Packaging Catalog**

or visit our website at [www.bunzlpdpackaging.com](http://www.bunzlpdpackaging.com) to view our interactive catalog.

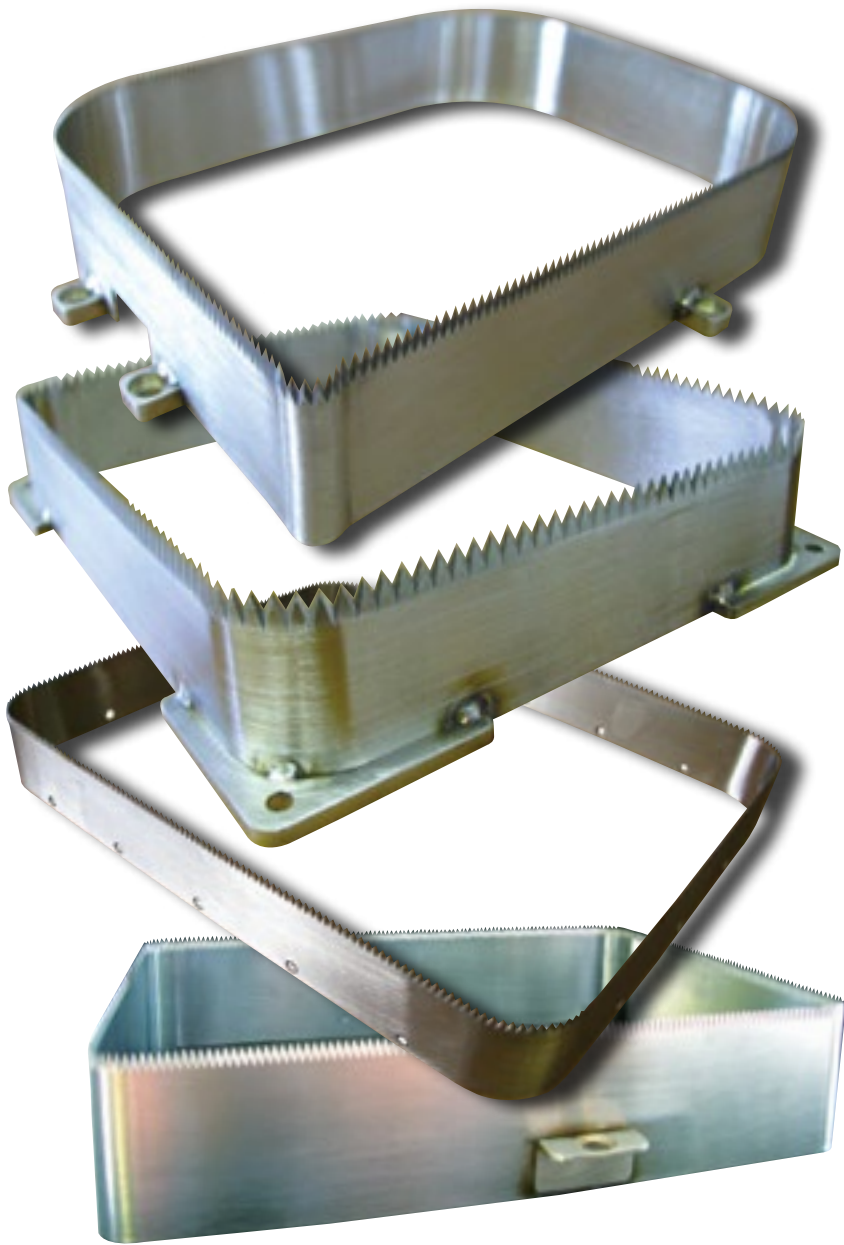

**CALL  
800-456-5624**

**FOR MORE INFORMATION AND PRICING**

## Tray Pack Blades for all Tray Pack Machines

*Short lead times and high quality products  
at affordable prices.*

- Single- and multi-lane tray pack blades are manufactured to the highest industry standards.
- Customize to suit unique shape and form requirements.
- Razor sharp tooth profile ensures quality cuts in even the most demanding of food packaging applications.

**REPLACEMENT\* FOR ALL OF THE MAJOR  
OEM'S IN THE MODIFIED ATMOSPHERE  
PACKAGING MACHINE SECTOR, SUCH AS:**



PRICES ARE SUBJECT TO CHANGE — CALL OR VISIT OUR WEBSITE FOR CURRENT PRICING.

\*All parts are manufactured for Bunzl Processor Division and are not made, licensed, sponsored or approved by the original equipment manufacturer. All products listed are **replacement parts only**; they are not an original equipment part of the manufacturers listed and Bunzl Processor Division is not affiliated with the manufacturers listed. All references to original manufacturer's equipment are for identification purposes only. All Bunzl parts are manufactured to exacting specifications using the highest quality materials.

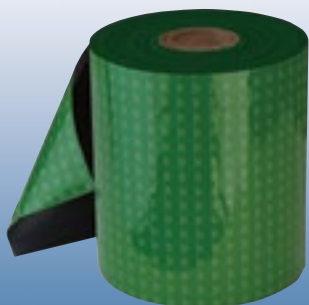

## Custom Printed Rollstock Web Film

Choose from custom printing on clear or black

**CALL FOR ORDERING INFORMATION  
& BUILD-A-ROLL FORM**

[www.bunzlpdpackaging.com](http://www.bunzlpdpackaging.com)





# PRIME Skinner Rollers, Pinch Blocks & Wear Strips

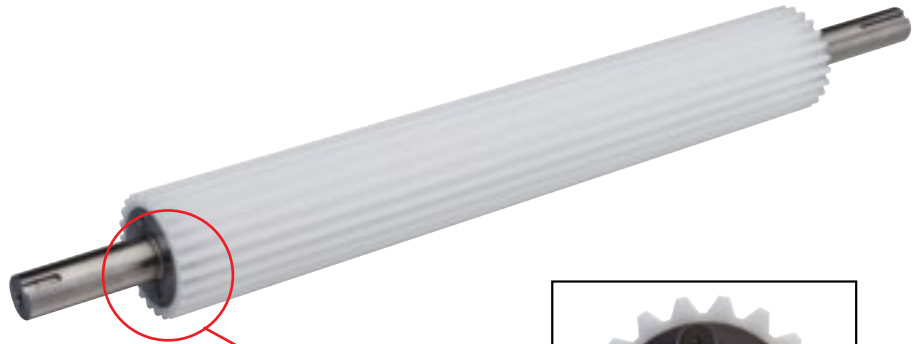

Rollers & Pinch Blocks available in 12", 18" and 24" sizes.

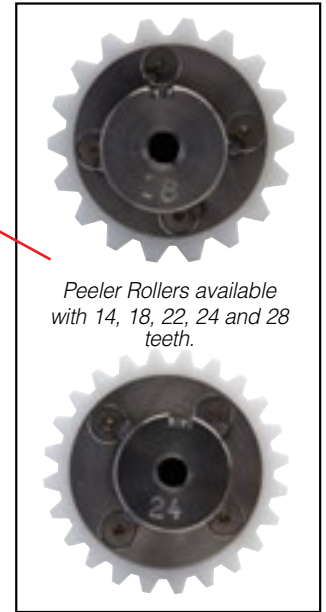

Peeler Rollers available with 14, 18, 22, 24 and 28 teeth.

Delrin upper Wear Strips

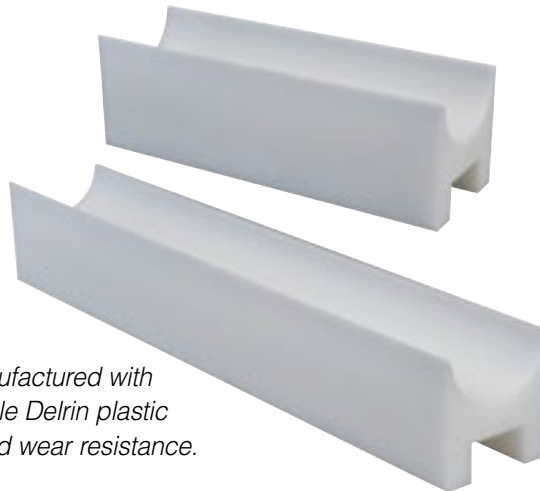

Manufactured with durable Delrin plastic for added wear resistance.

ITEM NO.	DESCRIPTION	SIZE	OEM #
H565 14241	10047-1424 Roller Skinner, 14-Tooth . . . . .	24" shaft . . . . .	TS020J/TP028B
H565 18181	10047-1818 Roller Skinner, 18-Tooth. . . . .	18" shaft . . . . .	SP020D/SP028B
H565 18241	10047-1824 Roller Skinner, 18-Tooth . . . . .	24" shaft . . . . .	TS020C/TP028
H565 20241	10047-2024 Roller Skinner, 20-Tooth. . . . .	24" shaft . . . . .	TS020ATP028B
H565 22181	10047-2218 Roller Skinner, 22-Tooth. . . . .	18" shaft . . . . .	SP020F/SP028B
H565 22241	10047-2224 Roller Skinner, 22-Tooth . . . . .	24" shaft . . . . .	TS020H/TP028
H565 24121	10048-2412 Roller Skinner, 24-Tooth, . . . . .	12" shaft. . . . .	SK202BSK028A
H565 24241	10047-2424 Roller Skinner, 24-Tooth . . . . .	24" shaft . . . . .	TS020E/TP028
H565 26241	10047-2624 Roller Skinner, 26-Tooth. . . . .	24" shaft . . . . .	TS020G/TP028B
H565 18251	10074-1824 Roller Skinner, 18-Tooth, Waterless. . . . .	24" shaft . . . . .	20678
H565 28241	10074-2824 Roller Skinner, 28-Tooth, Waterless. . . . .	24" shaft . . . . .	34412
H565 20121	10071-2012 Roller Skinner, 20-Tooth, Ertalyte. . . . .	12" shaft. . . . .	TD1004
H565 28121	10071-2812 Roller Skinner, 28-Tooth, Ertalyte. . . . .	12" shaft. . . . .	TD1004
H565 70121	10070-12 Block Pinch Skinner, Ertalyte. . . . .	12" shaft. . . . .	TT031AE
H565 51121	100751-12 Block Pinch Skinner, Delrin. . . . .	12" shaft. . . . .	TT031A
H565 52181	10042-18 Block Pinch Skinner, Delrin . . . . .	18" shaft. . . . .	SP031A
H565 53241	10053-24 Block Pinch Skinner, Delrin . . . . .	24" shaft . . . . .	TS031A
H565 10731	10073 Block Pinch Skinner, Waterless Delrin. . . . .	24" shaft . . . . .	28486
H565 10491	10049 Upper Wear Strip, Delrin. . . . .		TT130A
H565 10541	10054 Counter Roller Assembly. . . . .	24" shaft. . . . .	15543

PRICES ARE SUBJECT TO CHANGE — CALL OR VISIT OUR WEBSITE FOR CURRENT PRICING.



# PLUMA TECH®

DOIGTS DE PLUMEUSES  
FINGERS FOR PLUCKING

- Maximum flexibility and excellent plucking performance without damaging skin.
- Suitable for plucking all poultry types.
- Various round, oval, flat, speciality shapes & colors available.
- Compatible with: Meyn, Stork, Bayle, Systemate, Linco & others.

- Available models: ALC, ALCS, AM, AMC, AMN, AM145, CRT, J6, L, MG, PL, RL, RLD, RL2, RL3, RL10, RL92.

Call for specifications & ordering



## Poultry De-Boning Cones

- Cones made of Stainless Steel
- Threaded for easy assembly
- Cone shafts threaded on both ends



ITEM NO.	PRODUCT
H17910041	SS Poultry De-boning Cone, Flat bottom 4"
H17910051	SS Poultry De-boning Cone, Round bottom 4"
H17910081	8" Cone Shaft, threaded
H17910091	9" Cone Shaft, threaded
H17910101	10" Cone Shaft, threaded

## Char Marking Rings

When precooking patties (for example, beef, chicken, or soy patties) and other food products at a high production rate for fast food or for frozen dinners, it is often desirable to simulate the effect of broiling food products on a grill, which is commonly called "char marking" in the food processing industry.

Char marking improves the eye appeal of the product by branding spaced parallel stripes, giving the appearance that the product was broiled over charcoal on spaced grill bars.



Bunzl now offers Char Marking Rings for various further processing equipment specializing in the beef, pig, poultry and sheep industry.

ITEM NO.	PRODUCT
H565 00031	6" Pegged
H565 00041	6" Blind
H565 00061	4" Pegged
H565 00071	4" Blind

CALL FOR  
MORE INFORMATION

PRICES ARE SUBJECT TO CHANGE — CALL OR VISIT OUR WEBSITE FOR CURRENT PRICING.

## GROTE® Slicers

Used for bacon slicing, poultry, pork & beef industries.

Other sizes available upon request.  
Available in V-tooth & Knife-Edge



➤ 50 blades per pack.

ITEM NO.	PRODUCT	SIZE
C785 1014	Slicer Blade . . . . .	14'-4-3/8" x 1/2" x .020"



\*GROTE® is a registered trademark of J.E. Grote Company, Inc. This product is a **replacement part only**; it is not an original equipment part of and is not affiliated with J.E. Grote Company, Inc. All references to original equipment are for identification purposes only.

## Slicing Blades for Grasselli® Slicers

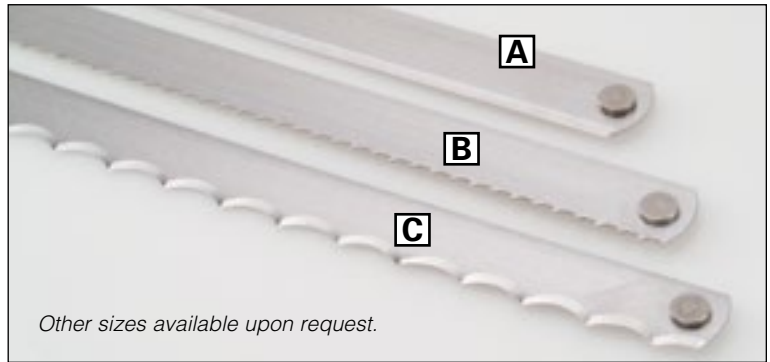

Other sizes available upon request.

➤ 25 blades per pack.

ITEM NO.	PRODUCT	SIZE
6466 0435	A. Knife Edge Slicer Blade . . . . .	17-5/8" x 5/8" x .020"
6466 0006	B. 6 TPI Slicer Blade . . . . .	17-5/8" x 5/8" x .022"
6466 7116	C. Scallop Edge Slicer Blade . . . . .	17-5/8" x 5/8" x .022"

➤ 50 blades per pack.

ITEM NO.	PRODUCT	SIZE
6466 6016	C. Scallop Edge Slicer Blade . . . . .	17-5/8" x 7/16" x .016"

\*This product is a replacement part; it is not an original equipment part of and is not affiliated with Grasselli Company. All references to original equipment are for identification purposes only.

## TOWNSEND® Peeler Blades

- Model 2600

➤ 20 blades per box.

ITEM NO.	OEM #
7949 30315	25515



\*TOWNSEND® is a registered trademark of Marel Meat Processing, Inc. This product is a replacement part it is not an original equipment part of and is not affiliated with Marel Meat Processing, Inc. All references to original equipment are for identification purposes only.

## RANGER® Peeler Blades

- .012" x .324" carbon steel.

➤ 10 blades per box.

ITEM NO.	OEM #
7949 3233	880242



\*RANGER® is a registered trademark of Olin Corporation. This product is a replacement part; it is not an original equipment part of and is not affiliated with Olin Corporation. All references to original equipment are for identification purposes only.

## Rib Pulling Handle and Blades

- Molded plastic handle.
- 6-1/4" stainless steel arm.
- Blades are easily replaced.

Blades and handle are sold separately.

ITEM NO.	PRODUCT
A657 34101	A. Rib Pulling Handle, each

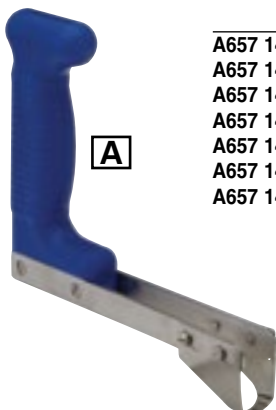

➤ Pack of 5

A657 14121	B. 12mm Blade
A657 14145	14mm Blade
A657 14165	16mm Blade
A657 14185	18mm Blade
A657 14205	20mm Blade
A657 14225	22mm Blade
A657 14255	25mm Blade

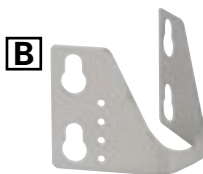

## Spinal Cord Remover

- Constructed of stainless steel to resist rusting.
- Heavy-duty yellow plastic handle.
- Pork blade is 1" in length and beef blade is 1-1/2" in length.
- Overall length is 7-1/4".
- Machine washable.



ITEM NO.	PRODUCT
6466 0600	Spinal Cord Remover
6466 0601	Beef Replacement Blade
6466 0602	Pork Replacement Blade

## Poultry Lung Scraper

- 12-1/2" overall length;
- 1" x 1-3/4" blade.
- Stainless steel with plastic handle.



ITEM NO.	PRODUCT
2990 10561	Stainless Steel Lung Scraper

PRICES ARE SUBJECT TO CHANGE — CALL OR VISIT OUR WEBSITE FOR CURRENT PRICING.





# Skinner Blades

Setting the standard for quality and precision.

- Engineered to provide maximum yields.
- Polished cutting edge eliminates product loading of cutting edge.
- Long lasting cutting edges reduce blade replacement downtime.
- Proven edge geometry for all applications.

➤ More sizes available. Call for details.

F.O.B. FACTORY

ITEM NO.	PRODUCT	OEM#	QTY/PACK
5880 6354	518mm x 22mm x 0.7mm. . . . .	16354 . . . . .	100 Individually Packaged
5880 82321	518mm x 25mm x 0.7mm. . . . .	18232100 . . . . .	100 Individually Packaged
5880 6952	365mm x 22mm x 0.7mm. . . . .	9726952 . . . . .	100 Individually Packaged
5880 61911	366mm x 25mm x 0.7mm. . . . .	9726191 . . . . .	minimums apply

Available sizes range from 77 mm to 1,000 mm long in either .7 mm or 1.0 mm thickness.

Blades are individually packed in a heat sealed safety package, preserving cutting edge integrity and protecting plant personnel.



## Hand Held Skinner Blades

- Fits Best and Donovan\* S-1011.



➤ 100 blades per box.

ITEM NO.	PRODUCT	SIZE
1060 0101	Carbon Steel	3-3/4" x 7/8"
5880 3062	Stainless Steel.	3-3/4" x 7/8"

\* BEST & DONOVAN® is a registered trademark of Best & Donovan N.A. This product is a replacement part; it is not an original equipment part of and is not affiliated with Best & Donovan N.A. All references to original equipment are for identification purposes only.

## LEBLANC™\* Loin Puller Blades

- 9-3/4".
- Different versions and shapes available for multiple applications. Call for more details.



\* LEBLANC™ is a registered trademark of G.E. Leblanc, Inc. This product is a replacement part; it is not an original equipment part of and is not affiliated with G.E. Leblanc, Inc. All references to original equipment are for identification purposes only.

➤ 50 blades per pack.

ITEM NO.	PRODUCT	OEM #
7949 0975	Left Hand . . . . .	81002216
7949 0976	Right Hand . . . . .	81002215

PRICES ARE SUBJECT TO CHANGE — CALL OR VISIT OUR WEBSITE FOR CURRENT PRICING.



**WORKHORSE®**  
**Cut-Resistant Gloves**  
Constructed of spun threads with fully encapsulated glass fibers and stainless steel.



**WORKHORSE® Stainless Steel Metal Mesh Gloves**  
Various sizes & styles available

Call or visit our website  
[www.bunzlpd.com](http://www.bunzlpd.com)  
for more information



Wrist length cuff.

Extended cuff.

Double reinforced rings at stress points

# Handheld Pneumatically Powered Dehider

*The world standard for skinning tools.*

- The #1 skinning tool worldwide for cattle, veal, hogs, and sheep.
- Highest possible hide quality — skins perfectly; no cuts, marks, or holes.
- High capacity, high performance tool, designed for long life and low maintenance.
- Super efficient motor design.
- Extra-thin head with stainless steel center plate for exceptional handling and enduring strength.



## JARVIS®

ITEM NO.	PRODUCT	MOTOR	OPERATING PRESSURES	AIR CONSUMPTION	BLADE SPEED/MIN	OVERALL LENGTH	WEIGHT
3028 4036	JC IIIA	.055-hp	.45 psi	12 CPM	6,500-7,000	13-in.	2.9-lbs.
3028 9038	JC IIIA	.055-hp	.90 psi	12 CPM	6,500-7,000	13-in.	2.9-lbs.
3028 41801	JC IVA	.070-hp	45-55 psi	15 CPM	6,500-7,000	13-in.	3.1-lbs.

## 110mm Dehider Blades

- Compatible with JC-III and JC-IV model dehiders.
- For use on cattle, veal, hogs and sheep.
- Skins perfectly: no cuts, marks or holes.



## JARVIS®

We are a full-line stocking distributor for Jarvis replacement parts and blades for all Jarvis tools.



Use your smartphone or tablet with a QR reader and scan this code to watch a video of the dehider in action.

ITEM NO.	PRODUCT	OEM #
3028 0155	110mm Dehider Blades	3023011

## Pneumatic Powered Circular Saw



## JARVIS®

CALL 800-456-5624 FOR MORE DETAILS ABOUT JARVIS PROCESSING EQUIPMENT

ITEM NO.	PRODUCT	OEM #
3028 1254	Air Power Circular Saw	4001028 SPC-165

Check out more Processing Tools & Accessories available on our website: [www.bunzlpd.com](http://www.bunzlpd.com)

PRICES ARE SUBJECT TO CHANGE — CALL OR VISIT OUR WEBSITE FOR CURRENT PRICING.

# JARVIS® SER-04 Reciprocating Breaking Saws

Electrically powered reciprocating saw for production breaking and general purpose use.



- Lightweight — 19 lbs. for ultimate flexibility.
- 1.9 hp motor. • Blade Speed: 4,100 strokes per minute.
- This electric saw is suitable for use on beef, hogs, sheep and veal.
- Common applications include cutting forequarters, shank bones, primal cuts, aitch bones, brisket opening and splitting.
- Overall Length: 20.5-in. • Weight: 19-lbs. • Blade Length: 8-/10-in.
- Meets national and international requirements for hygiene and safety.
- 1 phase, 50/60 Hz. • TEFC motor.
- Double insulated. • Ultra low vibration.
- Smoother more comfortable operation.

**ORDER BLADES & BLADE SUPPORTS SEPARATELY, SEE BELOW.**

ITEM NO.	PRODUCT
3028 11371	115V/13A, <i>Assembly Only</i>
3028 15651	230V/6.5A, <i>Assembly Only</i>



## Blades and Supports for SER-04

### End Cutting

ITEM NO.	PRODUCT
3028 15701	200 mm Blade and Support
3028 15711	200 mm Blade
3028 15721	200 mm Support
3028 15751	300 mm Blade and Support
3028 15771	300 mm Blade
3028 15791	300 mm Support
3028 15821	400 mm Blade and Support
3028 15831	400 mm Blade
3028 16101	400 mm Support

### Heavy Duty

ITEM NO.	PRODUCT
3028 16911	200 mm Blade and Support
3028 17031	200 mm Blade
3028 17041	200 mm Support
3028 17061	300 mm Blade and Support
3028 17281	300 mm Blade
3028 17311	300 mm Support
3028 17471	400 mm Blade and Support
3028 17481	400 mm Blade
3028 17511	400 mm Support

**WHEN YOU ARE READY TO UPGRADE TO JARVIS® JUST GIVE US A CALL. WE ACCEPT COMPETITORS' EQUIPMENT ON TRADE TOWARDS ANY NEW JARVIS® EQUIPMENT FOR YOUR PLANT.**

CALL **800-456-5624** FOR DETAILS.

PRICES ARE SUBJECT TO CHANGE — CALL OR VISIT OUR WEBSITE FOR CURRENT PRICING.



# JARVIS® Wellsaw 404

8,000 strokes per minute, 1-hp.

- Heavy-duty 1-hp motor 115v AC single phase.
- Reciprocating blade design allows cutting on both strokes at the rate of 8,000 strokes per minute, with a 1-1/8" stroke length.
- Quick action double-pole trigger switch.
- Teflon coated blade support.
- 10' heavy-duty, grounded 3-wire power cord.
- Weight: 11-lbs.



COMPLETE SAW SHOWN HERE.  
ORDER BLADE AND SUPPORT  
SEPARATELY BELOW.

## Wellsaw 404 Meat Saw Motor Drive

ITEM NO.	PRODUCT
3028 6127	Wellsaw 404 Motor Drive Assembly Only

ORDER BLADES & BLADE SUPPORTS SEPARATELY, SEE BELOW.



**TIP:** Purchase the Wellsaw 404 Service Kit (shown below) at the same time as the Wellsaw and SAVE!

## Wellsaw 404 Blades & Supports

### BLADES - 404

ITEM NO.	PRODUCT
3028 3122	8" Blade
3028 31211	16" Blade
3028 3123	8" Heavy-Duty Blade
3028 31241	16" Heavy-Duty Blade

Heavy-duty  
Blade

Standard  
Blade



### SUPPORTS - 404

ITEM NO.	PRODUCT
3028 8071	8" Blade Support
3028 8070	16" Blade Support
3028 8075	8" Heavy-Duty Blade Support
3028 8074	16" Heavy-Duty Blade Support

16" Standard  
Support

8" Standard  
Support



## Wellsaw 404 Service Kit

**SAVE OVER \$25** when purchased with a 404 Wellsaw.

- Contains these recommended spare parts to service saw: Switch, Screw, Stud, Hex Key, Grease, Pinion Gear and Bottom Plate Gasket.
- We recommend a service kit be ordered with every Wellsaw 404.

ITEM NO.	PRODUCT
3028 11521	Wellsaw 404 Service Kit

SAVE \$\$ WHEN PURCHASED  
WITH WELLSAW

**SAVE WHEN YOU  
PURCHASE ALONG WITH  
A 404 WELLSAW!**



PRICES ARE SUBJECT TO CHANGE — CALL OR VISIT OUR WEBSITE FOR CURRENT PRICING.



# JARVIS® Wellsaw 444

6,300 strokes per minute, 2-hp.

- Heavy-duty 2-hp motor 115v AC single phase.
- Reciprocating blade design allows cutting on both strokes at the rate of 6,300 strokes per minute, with a 1-1/2" stroke length.
- Adjustable ring for overhead counter balance attachment.
- Quick action double-pole trigger switch.
- Teflon coated blade support.
- 10' heavy-duty, grounded 3-wire power cord.
- Weight: 26-lbs.

**DID YOU KNOW  
WE OFFER  
REPAIR SERVICE  
FOR WELLSAWS?**

*Call for details.*

## Wellsaw 444 Meat Saw

ITEM NO.	PRODUCT
3028 5252	16" Wellsaw 444 Complete Unit

*Includes 16" heavy-duty blade and support.*

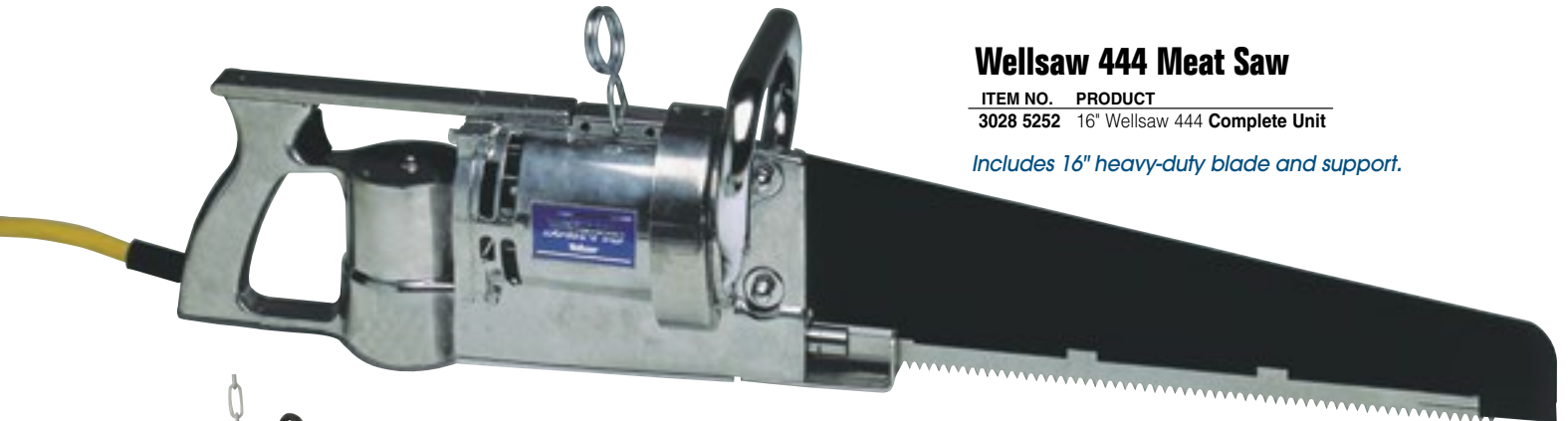

*Order KROMER™ Balancer Item No. 1968 0025.  
Call for more information.*

# JARVIS®

*We are a full-line stocking distributor for Jarvis® replacement parts and blades for all Jarvis® tools.*

## Replacement Blades and Supports for Wellsaw 444

### BLADES

ITEM NO.	PRODUCT
3028 3123	8" Replacement Blade
3028 31241	16" Replacement Blade

### SUPPORTS

ITEM NO.	PRODUCT
3028 8073	8" Blade Support
3028 8072	16" Blade Support

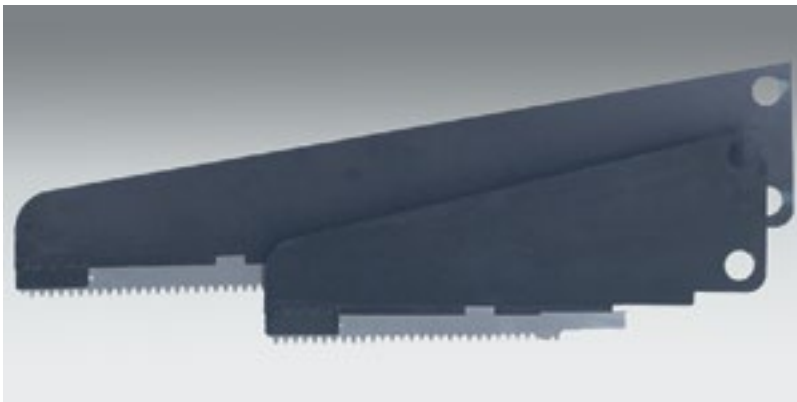

## Replacement Blade and Support for Wellsaw 400

ITEM NO.	PRODUCT
3028 0005	16" Blade Support
3028 0007	16" Blade 8 tpi (NOT for Food Product)
3028 31211	16" Blade (For Food Product)

PRICES ARE SUBJECT TO CHANGE — CALL OR VISIT OUR WEBSITE FOR CURRENT PRICING.

# JARVIS®

We are a full-line stocking distributor for Jarvis® replacement parts and blades for all Jarvis® tools.



Scan this code with your smartphone QR reader for a Buster Bandsaw product video.

## Buster Carcass Splitting Bandsaws

The world leader in splitting technology.



- Electrically powered bandsaws for splitting cattle, bulls, oxen and pork.
- The largest Jarvis splitting saw; suited for the largest carcasses.
- Best possible hygiene — spoked wheels, flat surfaced housings and completely opening doors — for fast, easy and complete cleaning.
- The drive system is oil bath lubricated for sustained trouble-free operation.
- Ultra-thin rail for unobstructed vision and dual rear handles for comfort.
- Anti-tie down controls and totally enclosed electric motor for operator safety.
- Meets national and international requirements for hygiene and safety.
- Superior blade life.

**JARVIS SERVICE TECHNICIANS ARE AVAILABLE TO PROVIDE FREE CUSTOMER SERVICE, INCLUDING EQUIPMENT INSTALLATION, SERVICE CALLS AND EMPLOYEE TRAINING.**

*Call for more details.*

### WHICH BUSTER IS RIGHT FOR YOU?

ITEM NO.	PRODUCT	HP	CAPACITY PER HOUR	DISTANCE BETWEEN GUIDES INCHES	OVERALL LENGTH INCHES	DRIVE WHEEL SPEED (RPM)	WEIGHT LBS
3028 1586	Buster IV Beef Carcass Splitter	3.3	180 Head	17.75	54	620	190
3028 1589	Buster V Beef Carcass Splitter	3.3	180 Head	19.75	57	530	196
3028 6060	Buster V Beef Loin Drop	3.3	900 Loins (450 Head)	22.75	59	530	187
3028 6107	Buster VI Pork Carcass Splitter	3.0	200 Sow/400 Hogs	17.1	51	657	138
3028 6147	Buster VI-ST Pork Carcass Splitter Stretch	3.0	200 Sow/400 Hogs	23.1	57.2	657	140
3028 6196	Buster IX Beef Carcass Splitter	3.3	180 Head	19.75	57	530	218
3028 6274	Buster X Pork Carcass Splitter	3.3	450 Head	19.6	57	657	162

### Replacement Blades for Buster Bandsaw

BLADE FOR THE FOLLOWING SAW:

BUSTER NO.	PRODUCT	BLADE LENGTH	STANDARD BLADE	CUT TOOTH BLADE	JET BLADE
3028 1586	Buster IV Carcass Splitter	119-in.	3028 0157	3028 3622	3028 3619
3028 1589	Buster V Carcass Splitter	127-in.	3028 0281	3028 3338	3028 3620
3028 6060	Buster V Beef Loin Drop	133-in.	3028 0533	—	—
3028 6107	Buster VI Pork Carcass Splitter	112-in.	3028 0156	—	—
3028 6147	Buster VI-ST Carcass Splitter Stretch	123.7-in.	3028 2595	—	—
3028 6196	Buster IX Carcass Splitter	127-in.	3028 0281	3028 3338	3028 3620
3028 6274	Buster X Carcass Splitter	112-in.	3028 0156	—	3028 36181

**CALL 800-456-5624 FOR BLADE PRICES**

### Recommended Balancers for Buster Bandsaw

BUSTER NO.	PRODUCT	RECOMMENDED BALANCER
3028 1586	Buster IV Carcass Splitter	1968 0033
3028 1589	Buster V Carcass Splitter	1968 0033
3028 6060	Buster V Beef Loin Drop	1968 0033
3028 6107	Buster VI Carcass Splitter	1968 0032
3028 6147	Buster VI-ST Carcass Splitter Stretch	1968 0032
3028 6196	Buster IX Carcass Splitter	1968 0034
3028 6274	Buster X Carcass Splitter	1968 0032

**CALL FOR DETAILS**

PRICES ARE SUBJECT TO CHANGE — CALL OR VISIT OUR WEBSITE FOR CURRENT PRICING.

## Stainless Steel Trigger Action Market Handsaws



- Stainless steel frame.
- Black ABS plastic handle.
- Available in two sizes.

**20" Includes 12 FREE Blades!**  
**25" Includes 12 FREE Blades!**

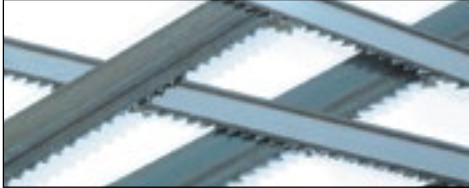

ITEM NO.	PRODUCT
3363 18201	20" Handsaw with 12 FREE Blades
3363 0825	25" Handsaw with 12 FREE Blades

**Buy Blades  
By The Dozen!**

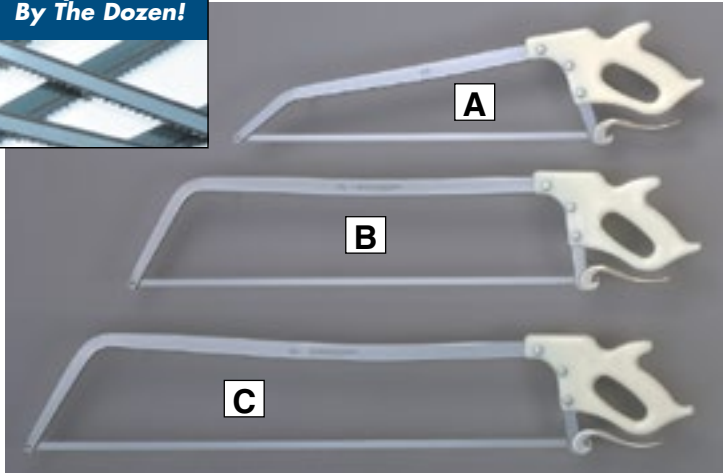

## Stainless Steel Trigger Action Handsaws

- Trigger blade tightener.
- Stainless steel frame.
- Ivory ABS plastic handle.

ITEM NO.	PRODUCT
6466 9010	A. Packer Saw, 20"
3363 0020	Replacement Blades, 20" (1 Dozen)
3363 0019	Replacement Blades, 19" (1 Dozen)
6466 9018	B. Market Saw, 20"
3363 0020	Replacement Blades, 20" (1 Dozen)
6466 9011	Market Saw, 25"
3363 0025	Replacement Blades, 25" (1 Dozen)
6466 9012	Market Saw, 27"
3363 0027	Replacement Blades, 27" (1 Dozen)
6466 9013	C. Splitting Saw, 30"
3363 0030	Replacement Blades, 30" (1 Dozen)
6466 0013	Replacement Handle
6466 0015	Replacement Nut (need 3 per handle)
6466 0016	Replacement Screws (need 3 per handle)

PRICES ARE SUBJECT TO CHANGE — CALL OR VISIT OUR WEBSITE FOR CURRENT PRICING.

**Additional supplies and equipment  
available in our Buyers Guide catalog.**

**Call to request your FREE copy!**

**800-456-5624**



**VISIT US ONLINE FOR OUR COMPLETE LINE OF  
KNIVES • CUTLERY • PROCESSING TOOLS • SHARPENERS • ACCESSORIES**

# INJECTOR NEEDLES



## Replacement\* Needle for Belam™

332mm OAL x 4mm, 4 (63) + 3 (56) Holes



## Replacement\* Needle for Fomaco

Item No. 5223 30031

305mm OAL x 4mm, 4 (67) holes — Double Needles



## Replacement\* Needle for Fomaco

371mm OAL x 4mm, 4 (57) Holes



## Replacement\* Needle for Mepsco

326mm OAL x 4mm, 4 (52) + 2 (46) Holes



## Replacement Needle for Metalquimia

305mm OAL x 3.2mm, 4 (74) + 2 (56) Holes



## Replacement\* Needle for Metalquimia

260mm OAL x 3mm, 4 (53) + 2 (53) Holes



PRICES ARE SUBJECT TO CHANGE — CALL OR VISIT OUR WEBSITE FOR CURRENT PRICING.

\*All parts are manufactured for Bunzl Processor Division and are not made, licensed, sponsored or approved by the original equipment manufacturer.

All products listed are **replacement parts only**; they are not an original equipment part of the manufacturers listed and Bunzl Processor Division is not affiliated with the manufacturers listed.

All references to original manufacturer's equipment are for identification purposes only. All Bunzl parts are manufactured to exacting specifications using the highest quality materials.



# INJECTOR NEEDLES



## Replacement\* Needle for Metalquimia

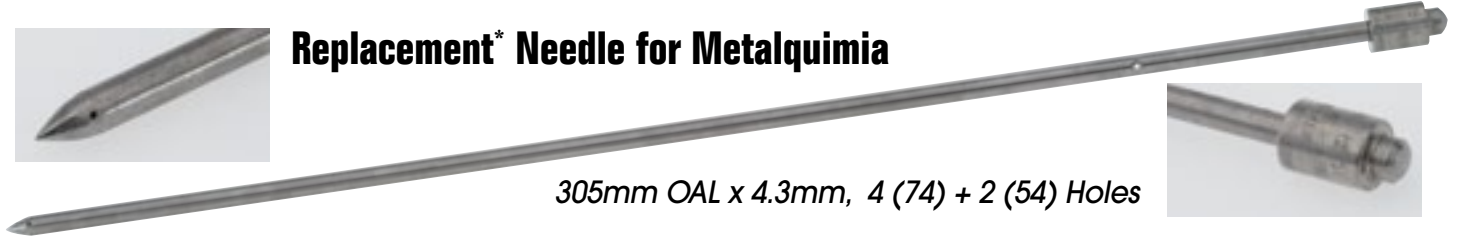

305mm OAL x 4.3mm, 4 (74) + 2 (54) Holes



## Replacement\* Needle for Metalquimia Style 89A

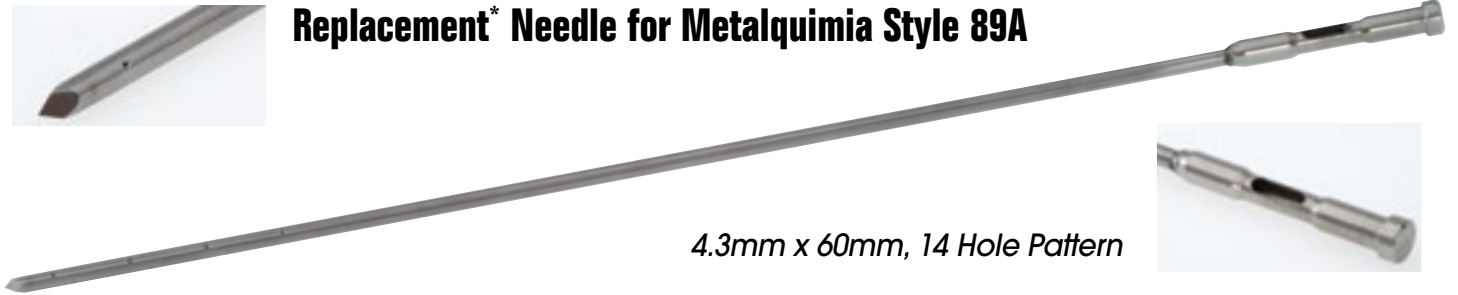

4.3mm x 60mm, 14 Hole Pattern



## Replacement\* Needle for Townsend

Item No. 0012 08085



160mm x 3/32"



## Replacement\* Needle for Schroder Wolf-Tec

Item No. 5223 00561

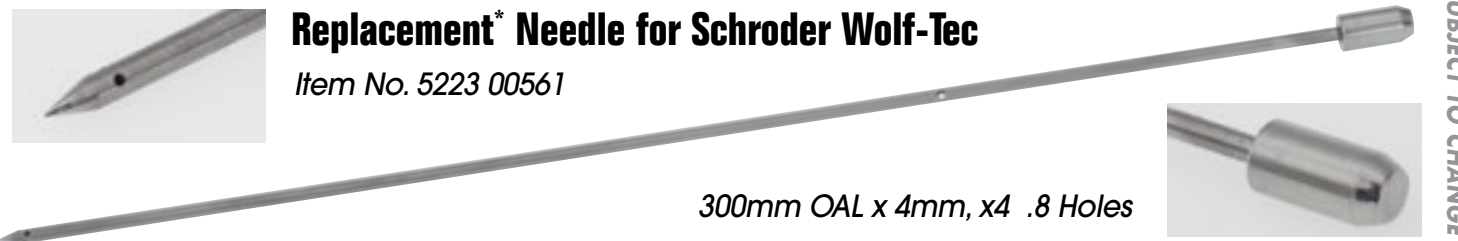

300mm OAL x 4mm, x4 .8 Holes



## Replacement\* Needle for Schroder Wolf-Tec IMAX 620

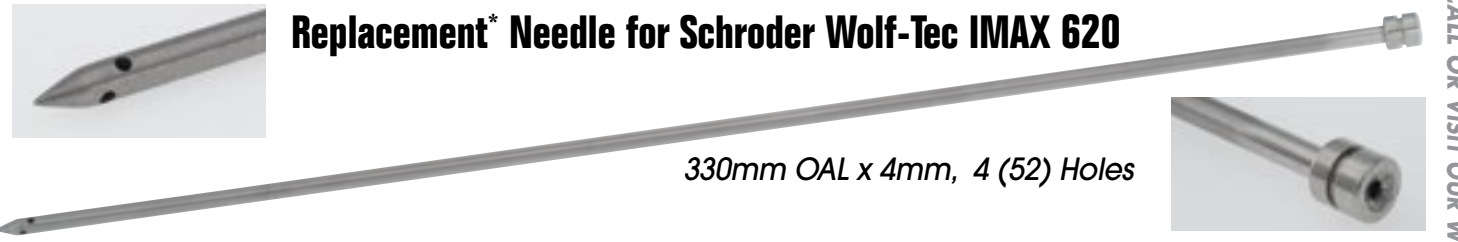

330mm OAL x 4mm, 4 (52) Holes



## Replacement\* Needle for Schroder Wolf-Tec

Item No. 0012 40841

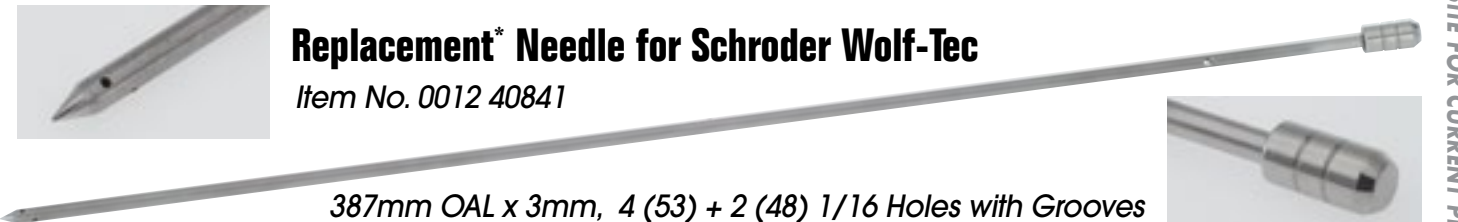

387mm OAL x 3mm, 4 (53) + 2 (48) 1/16 Holes with Grooves



\*All parts are manufactured for Bunzl Processor Division and are not made, licensed, sponsored or approved by the original equipment manufacturer. All products listed are **replacement parts only**; they are not an original equipment part of the manufacturers listed and Bunzl Processor Division is not affiliated with the manufacturers listed. All references to original manufacturer's equipment are for identification purposes only. All Bunzl parts are manufactured to exacting specifications using the highest quality materials.

PRICES ARE SUBJECT TO CHANGE — CALL OR VISIT OUR WEBSITE FOR CURRENT PRICING.

# CHOOSE JARVIS®

*Here are the reasons why:*

- Jarvis stunners consistently outperform other brands.
- 22 field support people dedicated to U.S. customers.
- Jarvis is **100% DEDICATED** to the protein industry.
- Over \$1 Million Jarvis products in stock and ready for immediate shipment.
- Repair service readily available.
- Jarvis tools are



MADE IN THE USA

## TRADE UP TO JARVIS!

*We accept competitors' equipment on trade towards any new Jarvis equipment.*



*Type-P and Type-C  
Power-Actuated  
Stunners available.*

*Jarvis stunning tools feature the latest innovation designs!*

- Touch-screen Smart Board technology.
- Laser accuracy measures bolt speed.
- Memory function recalls previous tool names and recorded bolt speeds.
- Exportable data log for stun test tracking.



*Featuring Smart Board Technology.*



# JARVIS®

CALL **800-456-5624** TO REQUEST

A **FREE** copy of our  
Humane Stunning Catalog

Interactive flipbook catalog available on our website:

[www.bunzlpd.com](http://www.bunzlpd.com)



**FREE ON-SITE CONSULTATIONS AVAILABLE!**  
*We'll assist you in determining the right humane  
stunning equipment needs for your environment.*

Jarvis Humane Stunning Tools are available exclusively in the U.S. through Bunzl Processor Division  
**READY TO MAKE THE CHANGE? 800-456-5624 • [www.bunzlpd.com](http://www.bunzlpd.com)**



# YOUR CUTLERY HEADQUARTERS



## QUALITY BRANDS YOU CAN TRUST



  
**VICTORINOX**  
SWISS ARMY

**For more CUTLERY products & brands  
visit us online [www.bunzlpd.com](http://www.bunzlpd.com)**

# BUNZL PROCESSOR DIVISION DISTRIBUTION CENTERS

*Our inventory includes over 35,000 ready-to-ship products from 14 distribution centers serving Central and North America, including the Caribbean and Mexico.*



Springdale, AR  
Fresno, CA  
Frederick, CO  
Atlanta, GA  
Eldridge, IA  
Liberal, KS  
Austin, MN  
North Kansas City, MO  
St. Pauls, NC  
Omaha, NE  
Fairfield, OH  
York, PA  
Dallas, TX  
Spokane, WA



**WWW.BUNZLPD.COM**

**Stay connected with us:**



*Scan this QR code with your mobile device for a direct link to our website.*